

CONTROLS



CONTROLS

CONTROLS RANGE

QUICK GUIDE



EMBEDDED CONTROL



WIRELESS CONTROL



WIRED CONTROL



PC TOOL



MOBILE APP

PRODUCTS SUITABILITY



HCV



HCC



HCH



CONTROLS PLATFORM SET UP

PLATFORM 1: HCH

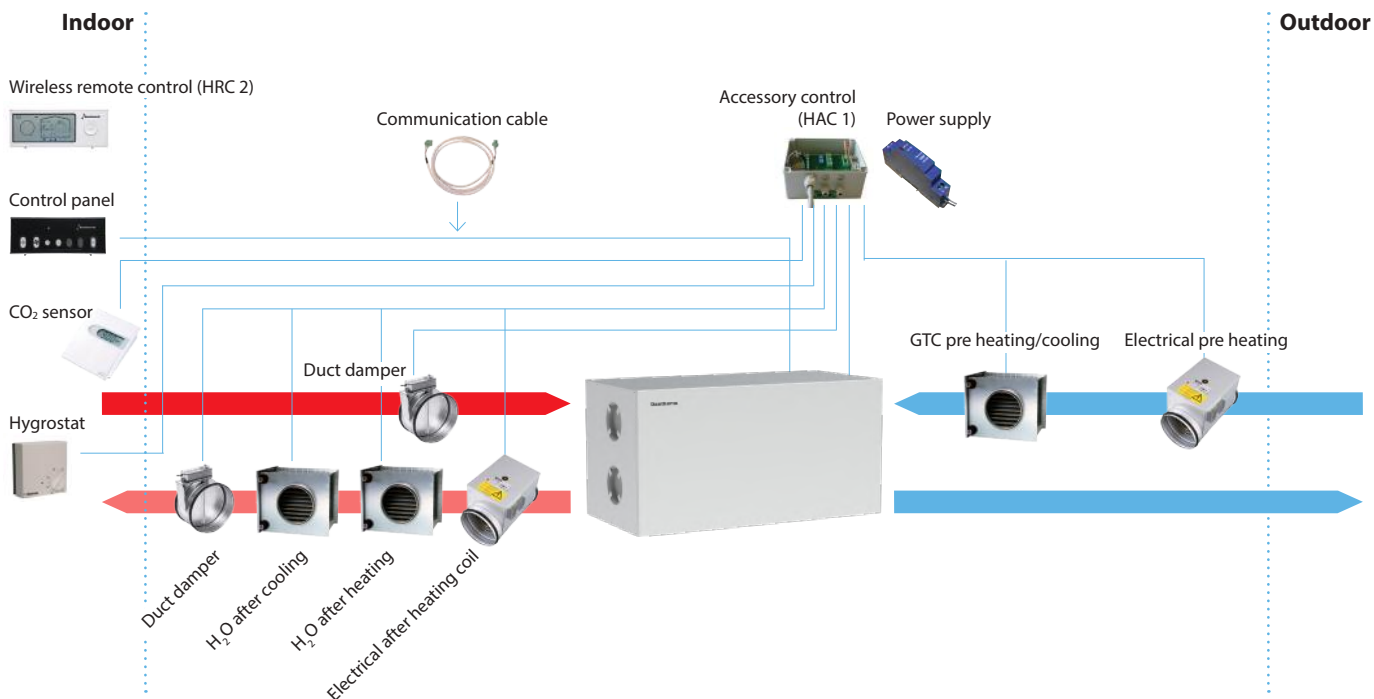

PLATFORM 2: HCC AND HCV

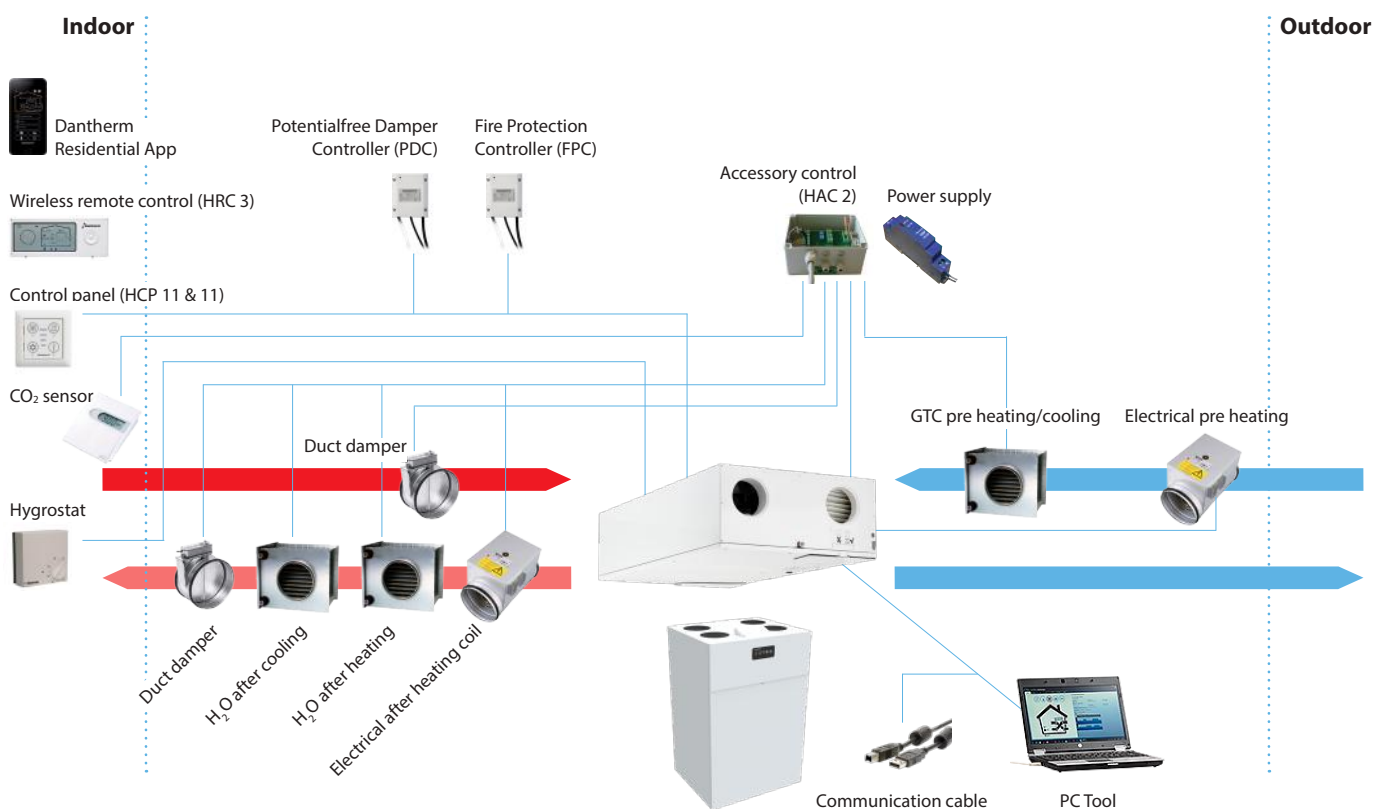

CONTROLS RANGE

EMBEDDED CONTROLS

HCV and HCC units have an embedded control which measures and adjusts all parameters continuously in order to maintain a correct ventilation level at the lowest possible energy consumption. The controller has a wide range of connections for both internal and external accessories.



Platform 2

The controller has a wide range of connections for both internal and external accessories.

For external connections, you will find:

- Wired LAN interface that supplies data communication to ModBus over TCP/IP
- Ideal for connection to external building management systems (BMS/CTS)
- ModBus over RS485: For HAC accessory control or wired control (HCP 11)
- Antenna socket for the wireless remote control antenna
- Two additional digital inputs that can be used for e.g. forced operation controlled by the hygrostat, cooker hood, fire protection or similarly

For more on internal accessories, please see the “Accessories” chapter.

The USB connection of the controller enables professional installers to carry out all adjustments and settings using the Dantherm PC Tool. The PC Tool is also capable of displaying both live and historic data for all unit components. This is crucially important in connection with maintenance, service and troubleshooting.

The USB port offers firmware update option.

The HCV units are secured against incorrect and uneconomical operation for long periods of time. Several of the functions return to default after four hours as a means of preventing excessive energy consumption, for instance if a unit is left running at maximum fan speed or in manual bypass mode. If you switch off the installation, it will automatically restart after four hours to ensure proper ventilation and to keep condensation from forming in the ducts and in the unit.

In emergency situations where there is a warning message about switching off ventilation systems and closing doors and windows, the supply current to the system must be interrupted by a safety switch or similarly.

CONTROLS RANGE

EMBEDDED CONTROLS

Control panel

The HCV unit has a built-in control panel with four buttons for controls, and nine LED feedback signals.

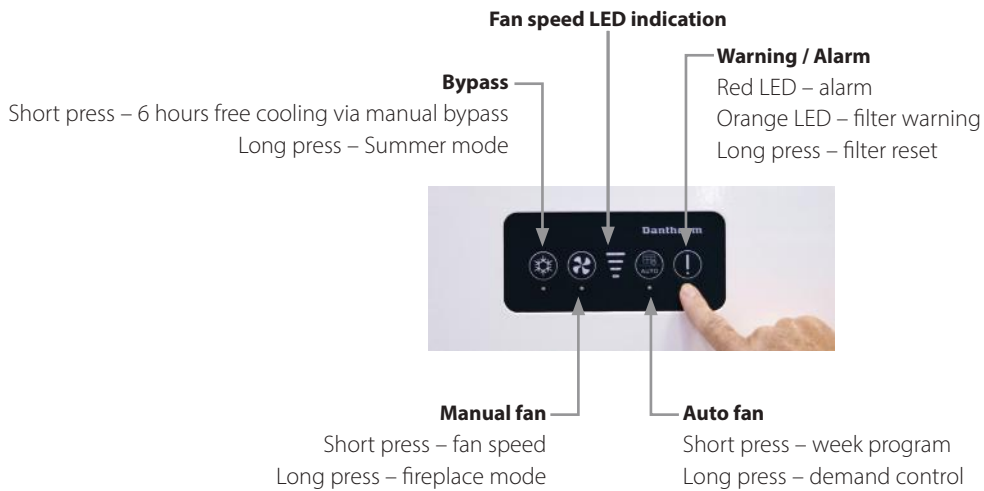

Fan control

During initial calibration, fan speed no. 3 is set on the control panel to the nominal air volume the house requires under normal usage.

The correlation between the four fan speeds on the control panel is as follows:

- Fan speed 0 = both fans stopped for 4 hours
- Fan speed 1 = 30% lower than fan speed 2
- Fan speed 2 = 30% lower than fan speed 3
- Fan speed 3 = nominal air change, set by installer during the initial calibration
- Fan speed 4 = 30% higher than fan speed 3 (4-hour time-out)

In demand-controlled mode with integrated humidity sensor, the maximum speed is step 3.

In demand-controlled mode with integrated VOC sensor or CO₂ sensor connected to the HAC 2, the maximum speed is step 4.

Filter control

The filter pressure is expected to increase between filter change intervals. To compensate for the reduced air volumes over time, the two fans run faster and faster until the filter alarm is triggered and the filter timer has been reset.

CONTROLS RANGE

WIRELESS REMOTE CONTROL

We offer a wireless remote control option, which can be mounted on the wall or placed on a shelf. The remote control is designed for the user, but also includes a special installer menu, allowing the installer to do extensive settings without the use of the PC Tool.

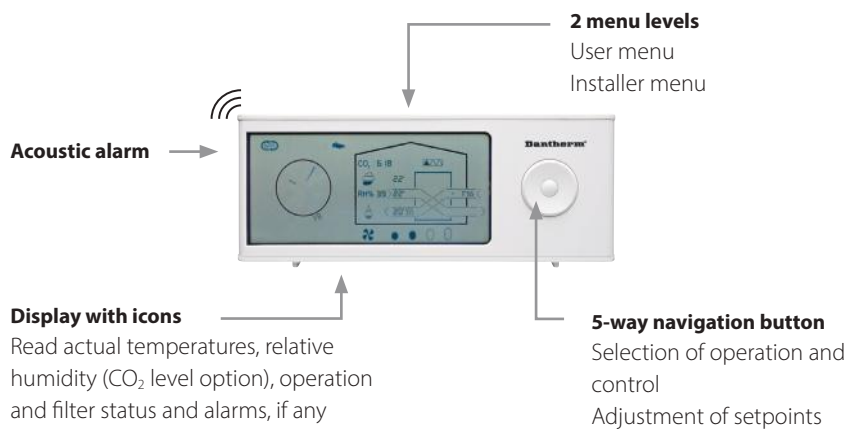

The user features are:

- Select fan speed in manual mode
- Select demand mode
- Select week mode, as well as selecting week program 1-11
- Manually activated by-pass
- Enable fireplace boost mode – seven minutes with overpressure inside the house for easy ignition of a fireplace
- Enable/disable away mode – the unit decreases permanently to fan speed 1
Enable/disable night mode – the unit decreases to fan speed 1. The hour for enable/disable can be adjusted.
- Adjust filter timer duration
- Reset filter timer after filter exchange
- Reading air temperatures in the duct connections, including the remote controls embedded temperature sensor
- Setting time and date

The remote control has a visual/acoustic alarm that will sound when the filter needs to be inspected or replaced. This ensures correct maintenance even when the unit is set to demand mode and your attention is not at the remote control.

The wireless remote control uses two AAA alkaline batteries. Battery lifetime of up to two years is possible, as the display and remote shifts to hibernation mode after two minutes without user interaction. In addition, the remote is shut down at night.

Illustration	Code	Description	HCV 300	HCV 400	HCV 460	HCV 500	HCV 700	HCH 5	HCH 8	HCC 2	HCC 260 P1	HCC 360 E1
	087953	Wireless remote control, HRC 3 Remote control with manual operation, demand-controlled operation, week program, away operation, night operation, readings and installer menu.	•	•	•	•	•			•	•	•
	065373	Wireless remote control, HRC 2 Remote control with manual operation, demand-controlled operation, week program, away operation, night operation, readings and installer menu.						•	•			

CONTROLS RANGE

WIRED CONTROL

Wired control (HCP)

This wired control comes with a white plastic frame and a metal frame for fastening into a standard junction box as well as a 6m communication cable. Alternatively, Dantherm can supply a box for fixing to the wall in an appropriate place.

The HCP 11 wired control gives the user the following possibilities :

- Manual control of air change (step 0-4)
- Control of air change with week program
- Demand controlled air change (when RH and VOC sensors are connected)
- Enable summer cooling mode (only extract air)
- Enable free cooling with bypass
- Enable fireplace mode
- Reading and resetting of alarms, including filter alarm

The installer can use the wired HCP 11 to adjust air volumes during commissioning.

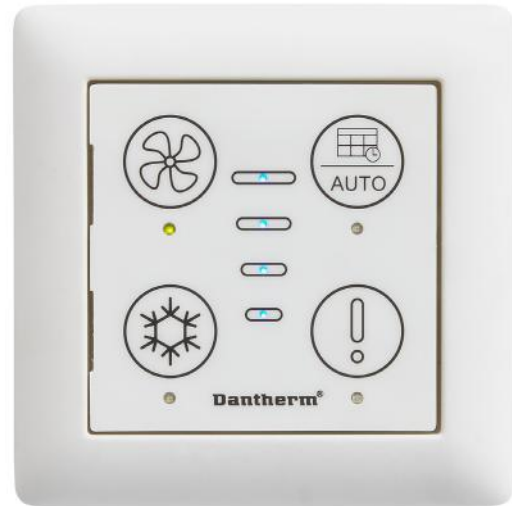



Illustration	Code	Description	HCV 300	HCV 400	HCV 460	HCV 500	HCV 700	HCH 5	HCH 8	HCC 2	HCC 260 P1	HCC 360 E1
	052539	Wired control, HCP 11 With acoustic alarm. Fire protection control compatible. Wired control with manual control, week program, demand control, summer cooling mode, free cooling with bypass, fireplace mode as well as air flow settings. Including 6m cable.	•	•	•	•	•			•	•	•

CONTROLS RANGE PC TOOL



The Dantherm PC Tool is available for all HCV and for HCC units. Though its installer menu, the installer can easily adjust the unit, connect extra accessories, adjust various user settings, read and reset alarms, if any.

It also has a user menu, where the user can read and adjust various settings, such as week programs, set points, alarms and historical data about temperatures and air quality (accessory).

CALIBRATION VIA PC TOOL



CALIBRATION USING CONTROL PANEL

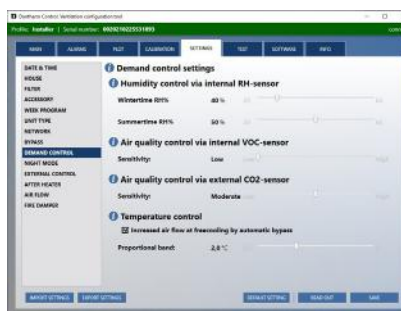

FILTER TIMER RESET



CONTROLS RANGE

DANTHERM APP

The Dantherm App, which is available for iOS and Android via the App store and Google play, offers a user-friendly and intuitive way to control the residential ventilation unit. The App is connected to the Wi-Fi router of the house. It is available for all HCV and HCC units.

The control options include:

- Demand control operation
- Manual operation
- Week program operation
- Night operation
- Manual bypass cooling
- Summer cooling.
- Fireplace mode
- Alarms
- Settings menu





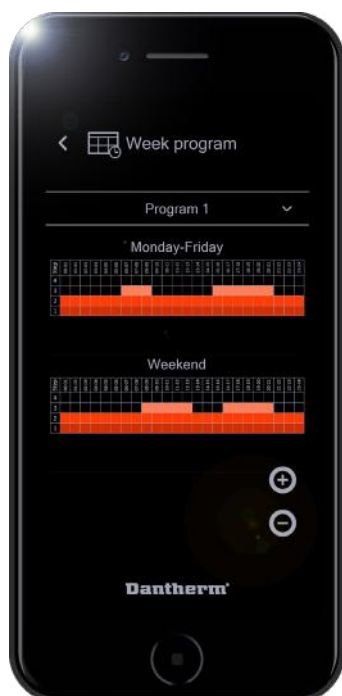







Easy to use! You can download it on Google Play or the App Store. Demo mode included.



CONTROLS ACCESSORIES

CONTROL ACCESSORIES RANGE

A wide range of additional control accessories are available in order to cover any specific need for control and system optimisation.

Illustration	Accessory	Description	HCV 300	HCV 400	HCV 460	HCV 500	HCV 700	HCH 5	HCH 8	HCC 2	HCC 260P1	HCC 360E1
	516301	Hygrostat The hygrostat measures the humidity in wet rooms. Ideal for high-humidity rooms requiring an increased air change, for instance bathrooms.	●	●	●	●	●	▼	▼	●	●	●
	087243	Humidity sensor, 700mm The RH% demand sensor will continuously monitor the humidity of the extract air and adjust the air flow level accordingly.								●	●	●
	087244	Air quality sensor, 700mm The VOC sensor will continuously monitor the level of artificial as well as natural organic fumes in the air and adjust the air flow level accordingly.								●	●	●
	081447	Humidity sensor, 480mm The RH% demand sensor will continuously monitor the humidity of the extract air and adjust the air flow level accordingly.	●	●	●	●	●	●	●	●	●	●
	077195	Air quality sensor, 480mm The VOC sensor will continuously monitor the level of artificial as well as natural organic fumes in the air and adjust the air flow level accordingly.	●	●	●	●	●	●	●	●	●	●
	063874	CO₂ sensor For control of air change accordance with the CO ₂ level in a given room.	●	●	●	●	●	●	●	●	●	●
	096984	Antenna extender 5m.		●	●							
	098084	Potentialfree Damper Controller (PDC) For potential free ON/OFF control of damper motor. Up to 4 PDC per ventilation unit.	●	●	●	●	●			●	●	●
	098083	Fire Protection Controller (FPC) For connection of fire and smoke damper or smoke damper. Up to 4 FPC per ventilation unit.	●	●	●	●	●			●	●	●
	065389	Accessory control, HAC 1 For control of heating coils, geothermal cooling, duct damper, stop function, fire thermostat, CO ₂ sensor, hygrostat and alarms. Including 5m cable.						●	●			
	077138	Accessory control, HAC 2 For control of heating coils, geothermal pre-cooling/heating coils, duct dampers, stop function input, fire thermostat, CO ₂ sensor, hygrostat and alarms. Including 3m cable.	●	●	●	●	●			●	●	●

▼ Unit needs a HAC 1 to connect the hygrostat.

CONTROLS ACCESSORIES

HAC AND SENSORS



Accessory control HAC 2

Accessory control HAC 2

One or more of the following functions can be connected to the accessory control:

- After heating coils for water or electricity
- Geothermal preheating/pre-cooling coils
- 24 VDC duct damper outlet
- Stop function inlet
- Fire/smoke detector inlet
- External CO₂ sensor for demand control
- External hygrostat
- Filter alarm outlet
- General alarm

HAC 2 comes with 3m cable.



VOC air quality demand sensor

VOC air quality demand sensors

The unit can be fitted with a VOC air quality sensor. This sensor will continuously monitor the level of artificial as well as natural organic fumes in the air.

Examples of included fumes:

- Natural fumes, e.g. formaldehyde from building materials
- Chemical fumes from sprays, e.g. hair spray or perfumes
- Indoor pollution e.g. from smoking and printing with laser printer
- Fumes from fire-retardant substances in carpets, paint and furniture

Using the VOC sensor in demand mode will result in the correct level of ventilation with the lowest possible power consumption. If a wireless remote control or App is connected, the actual VOC level will be shown in the display using a 3 level icon.



Humidity sensor

Humidity RH% demand sensor

The ventilation units can be fitted with a humidity sensor (RH%). This sensor will continuously monitor the humidity of the extract air and adjust the air flow level in accordance with the demand of the home. Using demand mode will ensure the correct level of ventilation at the lowest possible electrical power consumption. The level of humidity is indicated in the Dantherm App as well as the wireless remote control (if connected). If VOC, CO₂ and RH% sensors have been fitted, the ventilation level will be determined by the sensor that detects the highest demand.

CONTROLS ACCESSORIES

FIRE PROTECTION CONTROLLER (FPC)

The Fire Protection Controller (FPC) is a unit that controls a fire damper for fire and smoke protection purposes. The unit has been designed for Belimo or similar fire damper actuators fitted with spring-return and position feedback. The fire damper actuator is connected directly to the FPC, and then controlled via the ventilation system. Each FPC is to be addressed individually. Up to four FPCs can be connected to one ventilation unit.

The FPC is fitted with LED lamps indicating the damper position and status, and a digital input socket for surveillance if so required in your installation, for instance for a thermostat or a smoke detector.



Fire Protection Controller (FPC)

Features

- Easy cable installation
- Individual alarm and damper status
- Digital input for thermostat or smoke detector for surveillance where required
- LED lamps indicate damper position and status
- Weekly or monthly self-test

For decentralised ventilation applications, the most frequently used solution is to lead exhaust air from each apartment and to the roof through separate air ducts. The ducts are fireproofed and joined in one exhaust air cowl. Such a solution often requires more ventilation shaft space than available, particularly in connection with renovation projects. Instead, the exhaust air can be removed using one joint air duct. But that requires fire and smoke dampers, fire thermostats and external automatic fire protection. Until now, this has dramatically increased the price of renovation projects.

Keeping installation costs for projects with joint air ducts at a very competitive level, Dantherm's new residential ventilation units have been fully prepared for control of fire and smoke dampers by means of the FPC.

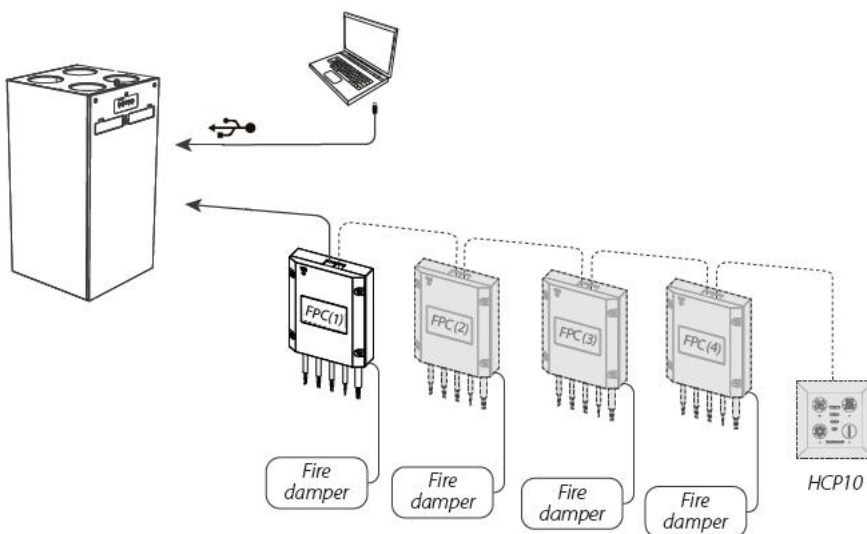

Fire Protection Controller set-up

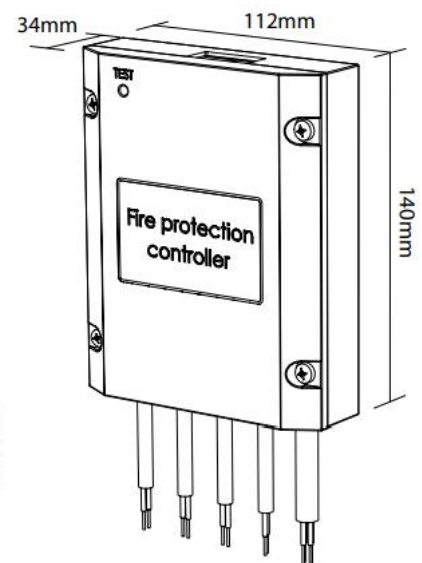

Dimensions

CONTROLS ACCESSORIES

FIRE PROTECTION CONTROLLER (FPC)

The ventilation unit controls the FPC which in turn controls the fire and smoke dampers by means of the connected fire thermostats and smoke sensors. When a fire is detected, the ventilation unit is shut down and the fire and smoke dampers are closed. That stops smoke from spreading to other apartments. The ventilation keeps running in apartments where there is no fire.

Fire control features:

Activation of the digital input, for instance if fire or smoke is detected

- The ventilation unit is shut down
- The fire and smoke damper is closed

Loss of power or stopped ventilation unit

- The fire and smoke damper is closed

Faulty components, wiring and bus communication

- The ventilation unit is shut down
- The fire and smoke damper is closed
- The ventilation unit displays an FPC error and logs it in the alarm log

Weekly or monthly self-test

- Shuts down the ventilation unit, closes the fire and smoke damper and tests the position feedback
- Opens the fire and smoke damper, tests the position feedback and powers up the ventilation unit
- If faults are registered, the fire damper is closed, the ventilation unit is shut down and the display will report an error which will be registered in the alarm log

Manual test activated using the PC Tool in connection with

- Annual testing of automatic control as well as fire and smoke dampers
- Testing before apartment occupancy

After faults, the ventilation units must be reset manually using the control panel. Automatic and manual tests are registered in the alarm log of the unit.

Power	Unit	Connection
Damper motor supply	24V/230V AC	Terminal 1&2 Wago cage clamp
Position feedback Digital input for dry contact use SPDT connections for open/close feedback	12V/12mA	Terminal S1-S6 Wago cage clamp
Thermostat/smoke detector For dry contact use	12V/12mA	Terminal 10-11 Wago cage clamp
RS 485 communication ModBus RTU protocol	12V/A-B	RJ11 696C
Power consumption		Max 100mA

Dantherm A/S

Marienlystvej 65
DK-7800 Skive
Denmark
t. +45 96 14 37 00

Dantherm Ltd.

Unit 12, Galliford Road
Maldon CM9 4XD
United Kingdom
t. +44 (0)1621 856611

Dantherm GmbH

Oststraße 148
22844 Norderstedt
Germany
t. +49 40 526 8790

Dantherm S.p.A.

Via Gardesana 11
37010 Pastrengo (VR)
Italy
t. +39 045 6770533

Dantherm Sp. z o.o.

ul. Magazynowa 5a
62-023 Gądki
Poland
t. +48 61 65 44 000

Dantherm SP S.A.

C/Calabozos 6
(Polígono Industrial)
28108 Alcobendas, Madrid
Spain
t. +34 91 661 45 00

Dantherm SAS

23 rue Eugène Henaff
69694 Vénissieux Cedex
France
t. +33 4 78 47 11 11

Dantherm AS

Løkkeåsveien 26
3138 Skallestad
Norway
t. +47 33 35 16 00

Dantherm AB

Fridhemsvägen 3
602 13 Norrköping
Sweden
t. +46 (0)11 19 30 40

Dantherm LLC

Transportnaya 22/2
142800, Stupino
Moscow
Russia
t. +7 (495) 642 444 8

MCS China

Unit 2B, No. 512
Yunchuan Road
Baoshang, Shanghai, 201906
China
t. +8621 61486668

Termigo S.L

Carrer dels Velluters, 18-2
46980 Paterna, Valencia
Spain
t. +34 961 524 866

AirCenter AG

Täferstrasse 14
CH-5405 Baden Dättwil
Switzerland
t. +41 43 500 00 50

Heylo GmbH

Im Finigen 9
28832 Achim
Germany
t. +49 4202 97550

SET Energietechnik GmbH

August-Blessing-Straße 5
Hemmingen, 71282
Germany
t. +49 7150 94540

Dealer:

KEEP UPDATED
FOLLOW US ON:

